

Specifications

Nominal Voltage		2 V
Capacity (25 °C)	10HR(1.80V)	100 Ah
	3HR(1.75V)	76.5Ah
	1HR(1.75V)	56.5Ah
Dimension	Length	171±2mm (6.73inch)
	Width	72±1mm (2.83inch)
	Height	205±2mm (8.07inch)
	Total Height	210±2mm (8.27inch)
Approx. Weight		5.8kg (12.8lbs)±4%
Terminal type		T10
Internal resistance (Fully charged, 25 °C)		Approx. 0.8mΩ
Capacity affected by temperature (10HR)	40°C	102%
	25°C	100%
	0°C	85%
	-15°C	65%
Self-discharge (25 °C)	3 month	Remaining Capacity: 91%
	6 month	Remaining Capacity: 82%
	12 month	Remaining Capacity: 65%
Nominal operating temperature		25 °C±3 °C(77°F ±5°F)
Operating temperature range	Discharge	-15°C ~ 50°C(5°F ~ 122°F)
	Charge	-10°C ~ 50°C(14°F ~ 122°F)
	Storage	-20°C ~ 50°C(-4°F ~ 122°F)
Float charging voltage(25°C)		2.25 to 2.30V Temperature compensation: -3mV/°C
Cyclic charging voltage(25°C)		2.42 to 2.48V Temperature compensation: -5mV/°C
Maximum charging current		20A
Terminal material		Copper
Maximum discharge current		800A(5 sec.)
Designed floating life(20°C)		10~12 years

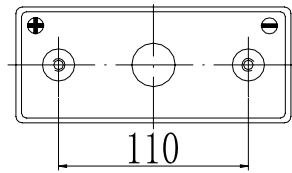

Dimensions

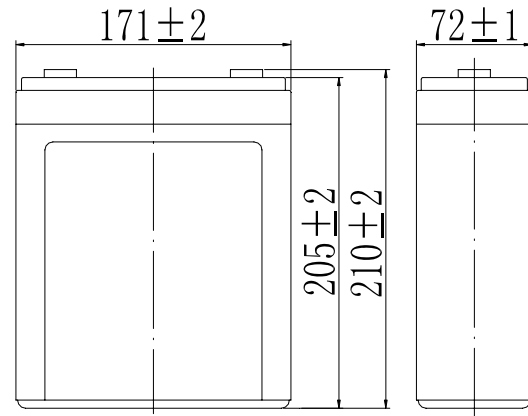

Terminal

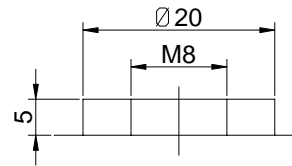

Terminal T10

- ◆ Absorbent glass mat technology;
- ◆ Recognized by UL & CE;
- ◆ ABS container.

Constant Current Discharge Characteristics (A, 25 °C)

F.V/TIME	15min	30min	60min	2h	3h	4h	5h	6h	8h	10h	20h
1.60V	135	90.0	60.0	36.5	26.0	20.9	18.2	15.6	12.2	10.2	5.34
1.65V	132	88.2	59.1	36.3	25.9	20.8	18.0	15.5	12.2	10.2	5.33
1.70V	127	85.5	57.6	36.0	25.7	20.6	17.9	15.4	12.1	10.1	5.32
1.75V	123	83.4	56.5	35.5	25.5	20.5	17.8	15.3	12.0	10.1	5.29
1.80V	116	80.4	54.7	34.6	24.7	19.9	17.3	14.8	11.6	10.0	5.25

Constant Power Discharge Characteristics (Watt, 25 °C)

F.V/TIME	15min	30min	60min	2h	3h	4h	5h	6h	8h	10h	20h
1.60V	247	168	114	70.5	51.0	41.0	35.8	30.7	24.4	20.3	10.7
1.65V	241	165	112	70.1	50.7	40.7	35.6	30.6	24.2	20.2	10.7
1.70V	232	160	109	69.5	50.3	40.5	35.3	30.4	24.0	20.2	10.6
1.75V	224	156	107	68.4	50.0	40.2	35.1	30.1	23.9	20.0	10.6
1.80V	212	150	104	66.7	48.5	39.0	34.0	29.2	23.2	19.9	10.5

Note: The above characteristics data can be obtained within three charge/discharge cycles.

Discharge Characteristics(25°C)

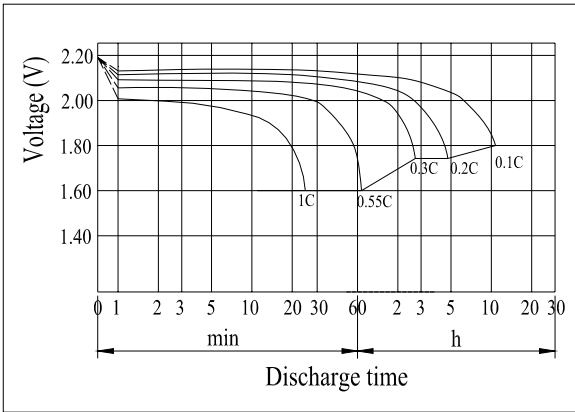

Charging Characteristics(25°C)

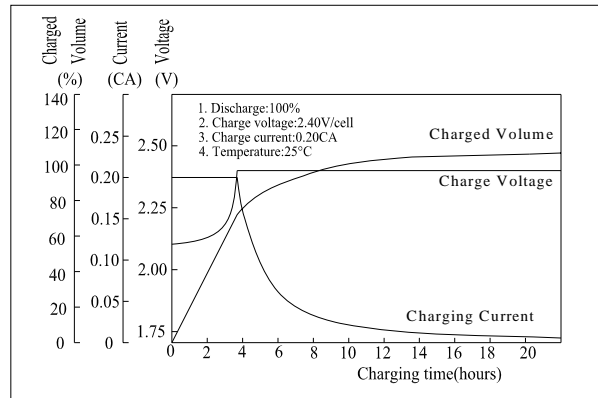

Effect of Temperature on Capacity

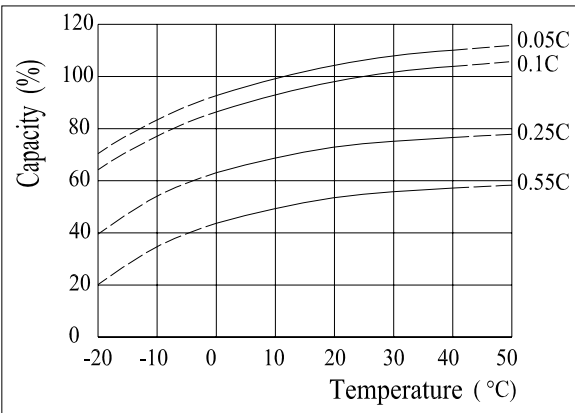

Self-discharge Characteristics

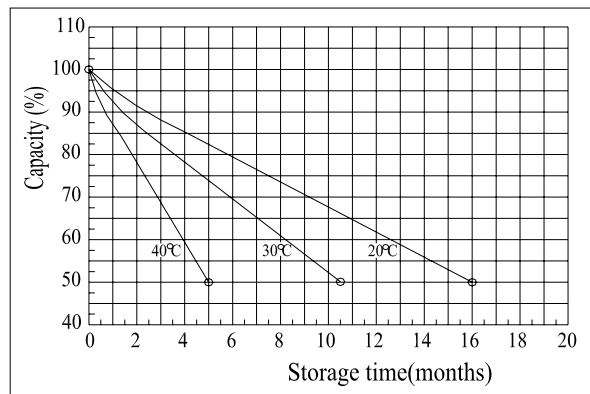

The Relationship for Open Circuit Voltage and Residual Capacity (25°C)

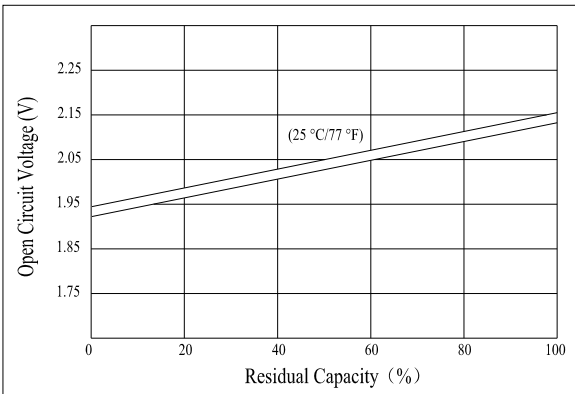

The Relationship for Charging Voltage and Temperature

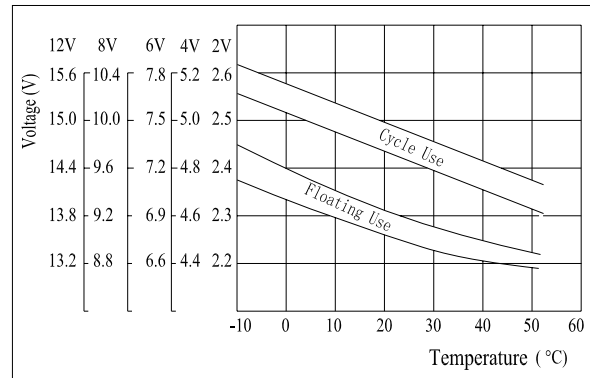

Floating Life on Temperature

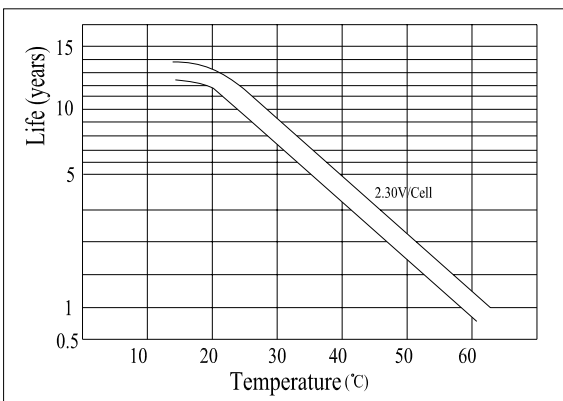

Cycle Life on D.O.D(25°C)

