



■ Features :

- Universal AC input / Full range (up to 305VAC)
- Built-in active PFC function
- High efficiency up to 91%
- Protections: Short circuit / Overload / Over voltage / Over temperature
- Cooling by free air convection
- Fully isolated plastic case
- Fully encapsulated with IP67 level (Note.6)
- Suitable for LED lighting and moving sign applications
- Compliance to worldwide safety regulations for lighting
- Suitable for dry / damp / wet locations
- 3 years warranty



SPECIFICATION

MODEL		LPF-90-15	LPF-90-20	LPF-90-24	LPF-90-30	LPF-90-36	LPF-90-42	LPF-90-48	LPF-90-54	
OUTPUT	DC VOLTAGE	15V	20V	24V	30V	36V	42V	48V	54V	
	CONSTANT CURRENT REGION Note.4	9 ~ 15V	12 ~ 20V	14.4 ~ 24V	18 ~ 30V	21.6 ~ 36V	25.2 ~ 42V	28.8 ~ 48V	32.4 ~ 54V	
	RATED CURRENT	5A	4.5A	3.75A	3A	2.5A	2.15A	1.88A	1.67A	
	RATED POWER	75W	90W	90W	90W	90W	90.3W	90.24W	90.18W	
	RIPPLE & NOISE (max.) Note.2	150mVp-p	150mVp-p	150mVp-p	200mVp-p	200mVp-p	200mVp-p	200mVp-p	200mVp-p	
	VOLTAGE TOLERANCE Note.3	±4.0%	±4.0%	±4.0%	±4.0%	±4.0%	±4.0%	±4.0%	±4.0%	
	LINE REGULATION	±0.5%	±0.5%	±0.5%	±0.5%	±0.5%	±0.5%	±0.5%	±0.5%	
	LOAD REGULATION	±1.5%	±1.0%	±0.5%	±0.5%	±0.5%	±0.5%	±0.5%	±0.5%	
	SETUP, RISE TIME Note.8	2000ms, 80ms / 115VAC at full load				1000ms, 80ms / 230VAC at full load				
HOLD UP TIME (Typ.)	16ms at full load				230VAC / 115VAC					
INPUT	VOLTAGE RANGE Note.5	90 ~ 305VAC		127 ~ 431VDC						
	FREQUENCY RANGE	47 ~ 63Hz								
	POWER FACTOR	PF ≥ 0.96/230VAC			PF ≥ 0.96/115VAC at full load and rated output voltage			PF ≥ 0.9 at 60 ~ 100% load		
	EFFICIENCY (Typ.)	89%	90%	90.5%	91%	91%	91%	91%	91%	
	AC CURRENT	0.95A / 115VAC		0.5A / 230VAC		0.4A / 277VAC				
	INRUSH CURRENT(Typ.)	COLD START 70A/230VAC								
	LEAKAGE CURRENT	<0.75mA / 277VAC								
PROTECTION	OVER CURRENT Note.4	95 ~ 108%								
	OVER VOLTAGE	18 ~ 21V	23 ~ 27V	28 ~ 34V	34 ~ 38V	41 ~ 46V	47 ~ 53V	54 ~ 60V	59 ~ 65V	
	OVER TEMPERATURE	100°C ±10°C (RTH2)								
ENVIRONMENT	WORKING TEMP.	-40 ~ +70°C (Refer to output load derating curve)								
	WORKING HUMIDITY	20 ~ 95% RH non-condensing								
	STORAGE TEMP., HUMIDITY	-40 ~ +80°C, 10 ~ 95% RH								
	TEMP. COEFFICIENT	±0.03%/°C (0 ~ 50°C)								
	VIBRATION	10 ~ 500Hz, 5G 12min./1cycle, period for 72min. each along X, Y, Z axes								
SAFETY & EMC	SAFETY STANDARDS Note.7	EN61347-1, EN61347-2-13 independent, IP67 approved ; Design refer to UL60950-1, TUV EN60950-1								
	WITHSTAND VOLTAGE	I/P-O/P:3.75KVAC								
	ISOLATION RESISTANCE	I/P-O/P:100M Ohms / 500VDC / 25°C / 70% RH								
	EMI CONDUCTION & RADIATION	Compliance to EN55015 Class B								
	HARMONIC CURRENT	Compliance to EN61000-3-2 Class C (≥60% load) ; EN61000-3-3								
OTHERS	EMS IMMUNITY	Compliance to EN61000-4-2,3,4,5,6,8,11; ENV50204, EN61547, EN55024, heavy industry level, criteria A								
	MTBF	356.4Khrs min. MIL-HDBK-217F (25°C)								
	DIMENSION	161*61*36mm (L*W*H)								
NOTE	PACKING	0.65Kg;20pcs/14Kg/ CUFT								
		<ol style="list-style-type: none"> 1. All parameters NOT specially mentioned are measured at 230VAC input, rated load and 25°C of ambient temperature. 2. Ripple & noise are measured at 20MHz of bandwidth by using a 12" twisted pair-wire terminated with a 0.1uf & 47uf parallel capacitor. 3. Tolerance : includes set up tolerance, line regulation and load regulation. 4. Constant current operation region is within 60% ~ 100% rated output voltage. This is the suitable operation region for LED related applications, but please reconfirm special electrical requirements for some specific system design. 5. Derating may be needed under low input voltages. Please check the static characteristics for more details. 6. Suitable for indoor use or outdoor use without direct sunlight exposure. Please avoid immerse in the water over 30 minute. 7. Safety and EMC design refer to EN60598-1, CNS15233, GB7000.1, FCC part18. 8. Length of set up time is measured at cold first start. Turning ON/OFF the power supply may lead to increase of the set up time. 9. The power supply is considered as a component that will be operated in combination with final equipment. Since EMC performance will be affected by the complete installation, the final equipment manufacturers must re-qualify EMC Directive on the complete installation again. 								

■ Mechanical Specification

Case No. LPF-90A Unit:mm

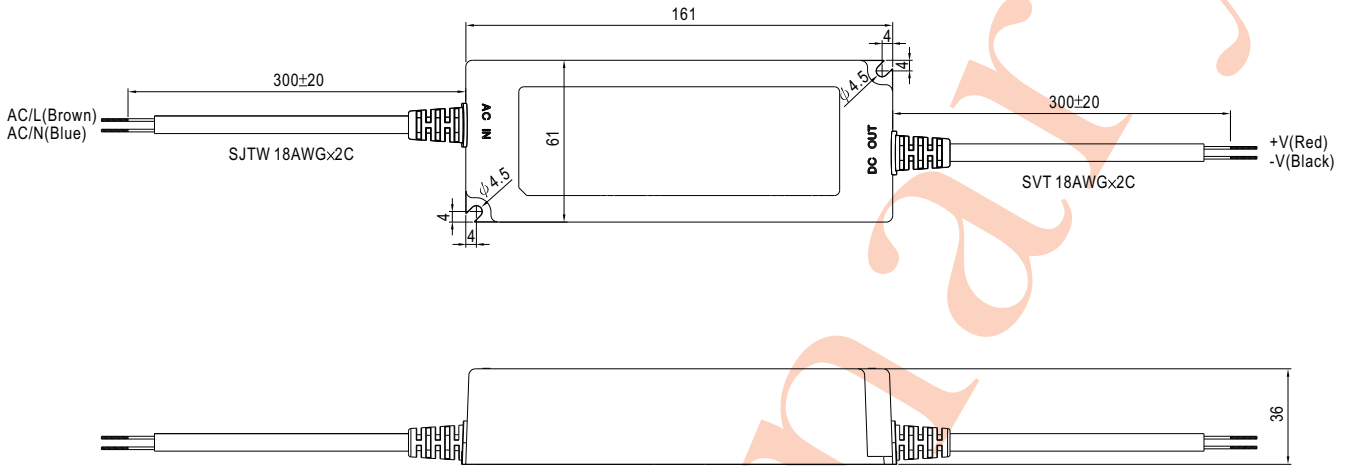

■ Block Diagram

fosc : 100KHz

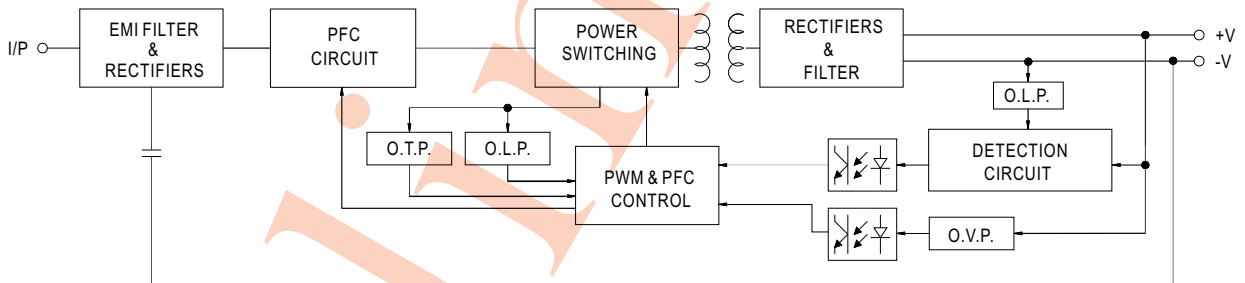

■ Derating Curve

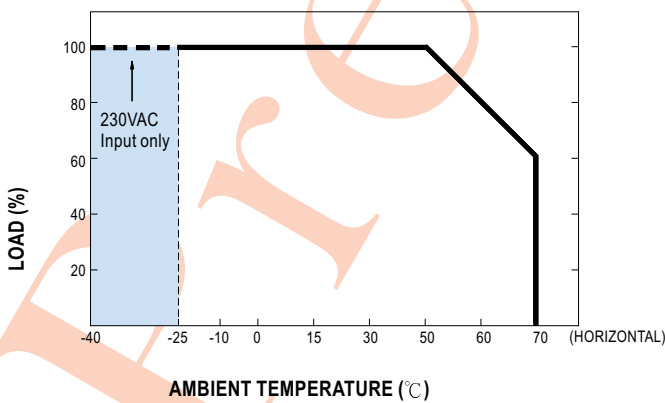

■ Static Characteristics

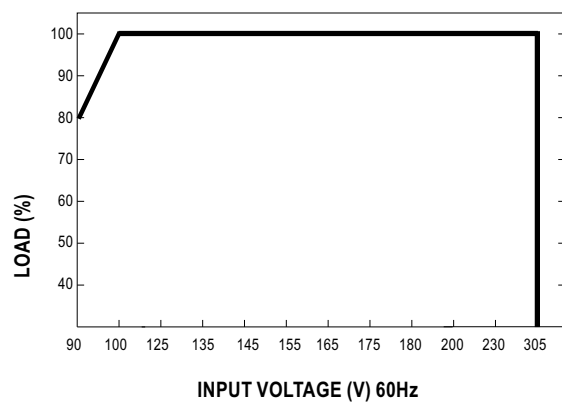

Power Factor Characteristic (48V Model)

Power factor will be higher than 0.9 when output loading is 60% or higher.

Constant Current Mode

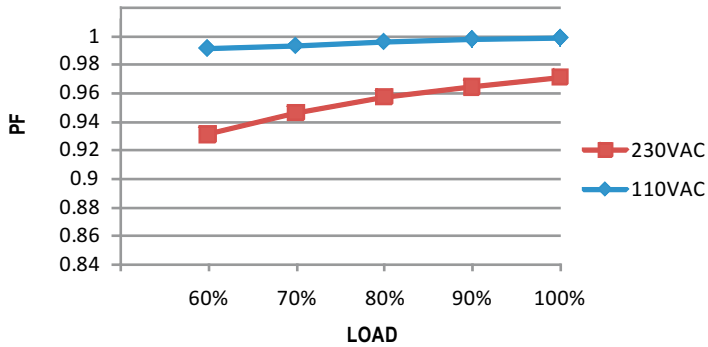

EFFICIENCY vs LOAD (48V Model)

LPF-90 series possess superior working efficiency that up to 91% can be reached in field applications.

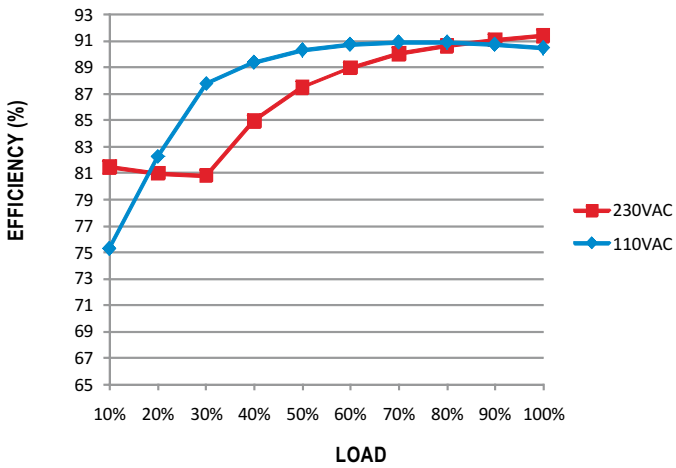

TOTAL HARMONIC DISTORTION vs LOAD (48V Model)

Total harmonic distortion will be lower than 20% when output loading is 60% or higher.

Constant Voltage Mode

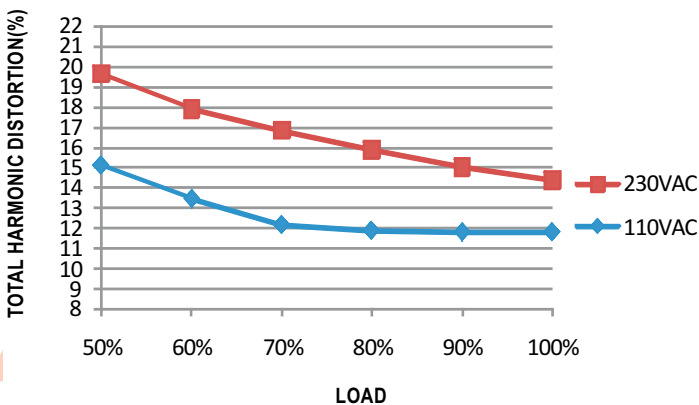

DRIVING METHODS OF LED MODULE

There are two major kinds of LED drive method "direct drive" and "with LED driver".

A typical LED power supply may either work in "constant voltage mode (CV) or constant current mode (CC)" to drive the LEDs.

Mean Well's LED power supply with CV+ CC characteristic can be operated at both CV mode (with LED driver, at area (A) and CC mode (direct drive, at area (B)).

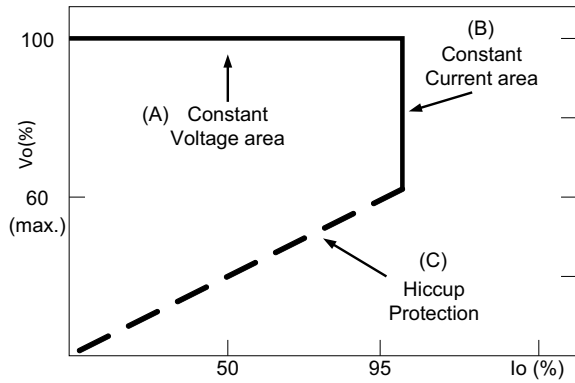

Typical LED power supply I-V curve

☉ **Direct driving :**

Under direct driving, the power supply will work in "constant current mode (CC)" and output voltage of the power supply will be clamped by sum of forward voltage (V_f) of the LED strip.

The total forward voltage of series connecting LEDs is suggested for 60%~95% of power supply rated output voltage due to concern of the best PF value and efficiency.

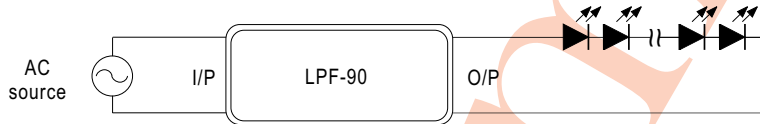

☉ **With LED driver :**

Using additional driver, the power supply will work in "constant voltage mode (CV)" and output voltage of the power supply will be kept in rated value.

In this drive mode, several design issues need to be considered:

1. Output voltage of PSU must be higher than total forward voltage of series connecting LEDs by 3V minimum.
2. Input capacitor (C_{in}) of LED driver circuit should use 47 μ F ~ 100 μ F (typ.) of rating depends on the operating frequency of the LED driver. The higher the operating frequency is used, the smaller value of C_{in} should be chosen, and vice versa.

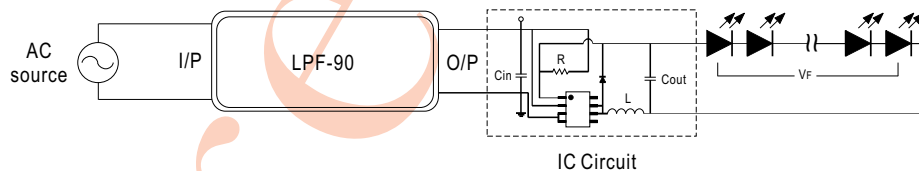

■ EMI DEBUG SUGGESTION

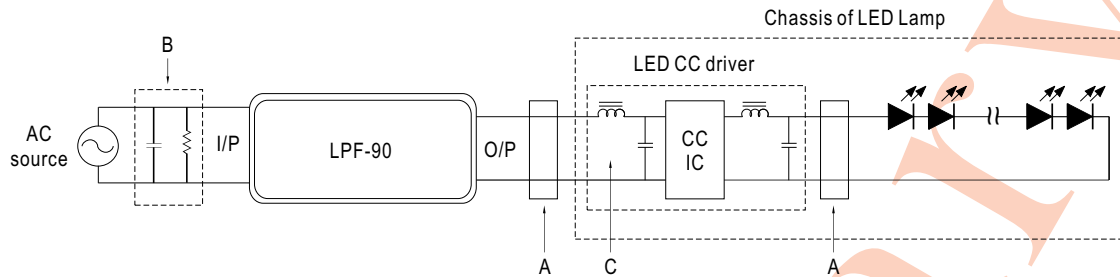

- A. Add a common mode ferrite choke on output wires to reduce the common emission between 10M ~ 300MHz per lighting EMI regulation.
- B. The additional X-Cap and discharge resistor can reduce the low frequency conduction noise between 9K ~ 1MHz per lighting EMI regulation.
- C. L-C filter should be added at the DC input of LED constant current driver to avoid the differential emission and high frequency noise generated by the CC driver.